

PYLE

OWNER'S MANUAL

PLD-189



FOLD DOWN DETACHABLE PANEL
CAR DVD/ VCD/ CD/ WMA/ MP3 PLAYER/ RECEIVER

www.pyleaudio.com

Thank you for buying this product.

Please read through these operation instruments so you will know how to operate your model properly. After reading please keep this booklet in safe place for future reference.

1 *Before You Start*

- Important Safeguards* 4
- About this manual* 4
- Precautions* 5
- Maintenance* 5
- Location & function of the controls* 7
- Remote control* 8
- Specifications* 8

2 *Installation*

- Wiring Connections* 12
- Installation* 13
- Install & Detach the Unit* 15
- Cleaning the Connector* 15

3 *General Operations*

- Reset the Unit* 17
- Turning the Unit On/Off* 17
- Volume Control* 17
- Setting the Sound Characteristics* 17
- EQ Setting* 17
- Turning Loudness On/Off / My Best Position* 17
- Mute Function* 17
- Display & Adjust Time* 17
- Mode Selector* 17
- Sensor* 17
- AUX In (optional)* 17

4 *DVD*

- Basic Operation of DVD* 18
- Selecting Tracks Fast* 18
- Repeat Playing* 18
- Number Buttons* 18
- Stop the Playback* 18
- Pause the Playback* 18
- Skip backward/forward/F.F/F.REW the Playback* 18
- System Button* 18
- Slow Motion Playback* 18
- Increase Picture Size* 18
- On Screen Display* 18
- DVD Playback Setting* 18
- Changing the Viewing Angle* 18
- Changing Audio Language* 18
- Changing the Subtitle Language* 18
- Selecting Menu* 18
- Set Up Menu* 18

5 *MP3/CD*

- Basic Operation of MP3* 20
- Selecting Tracks Fast* 20
- Repeat Playing* 20
- Number Buttons* 20
- Stop Playing* 20
- Selecting MP3 Tracks* 20
- Pause the Playback* 20
- Skip backward/forward/F.F/F.REW the Playback* 20
- On Screen Display* 20

Contents

6 VCD

- Basic Operation of VCD/CD* 28
- Selecting Tracks Fast* 28
- Repeat Playing* 28
- Playing Tracks in Random Order* 28
- Number Buttons* 28
- Stop the Playback* 28
- Pause the Playback* 28
- Skip backward/forward/F.F/F.REW the Playback* 28
- System Button* 28
- Slow Motion Playback* 28
- Increase Picture Size* 28
- On Screen Display* 28
- Setting Playback Time* 28
- Selecting Channel* 28
- Title Selector* 28
- Program Playing* 31

7 Tuner

- Band Selector* 32
- Manual/Automatic Tuning* 32
- DX/LOC Selector* 32
- MO/ST Selector* 32
- Scanning/Memorizing Stations Automatically* 32
- Number Buttons* 32

8 Additional Information

- Simple Troubleshooting Guide* 34

IMPORTANT SAFEGUARDS

1. **Be sure to connect the color coded leads according to the diagram. Incorrect connections may cause the unit to malfunction or damage the vehicle's electrical system.**
2. **Be sure to connect the speaker (-) leads to the speaker (-) terminal. Never connect the left and right channel speaker cables each other or to the vehicle body.**
3. **Make sure all the connections are completely correct before turning on your unit.**
4. **When replacing the fuse(s), the replacement must be of the same amperage as shown on the fuse holder.**
5. **Do not block vents or radiator panels. Blocking them will cause heat to build up inside and may result in fire.**
6. **After completing the installation and beginning to play the unit (including replacing the battery), please remove the front panel at first, and then press RESET button on the base with pointed object (such as ball-point pen) to set the unit to initial status.**

About this manual

This unit features a number of sophisticated functions ensuring superior operation. All the functions have been designed for the easiest possible use, but many are not self-explanatory. This manual will help you understand the functions and operations of the unit. This manual main explains **remote control operation**. However, in addition to those functions related with DVD/VCD/CD/MP3 operation that can only be operated by the remote control, there are also functions can be operated by the buttons provided for the main unit.

Before You Start

PRECAUTIONS

This unit can play the following discs only:

Type of disc	Label on the disc	Recorded material	Size of disc
DVD		Sound and moving pictures	12cm
VCD	 	Sound and moving pictures	12cm
CD		Sound only	12cm
MP3		Sound only	12cm

NOTE: The unit is compatible with VCD1.0/2.0/3.0 version and DVCD disc.

- **Do not attempt to modify the unit, modifying the unit may cause an accident.**
- **Stop the vehicle before carrying out any operation that could interfere with your driving.**
- **Do not work in extremely high or low temperature. Be sure the temperature inside the vehicle is between +60° C and -10° C before turning on your unit .**
- **To enjoy optimum sound and images while playing, handle the discs as follows:**

— Handle the disc by its edge to keep the disc clean, and do not touch the surface.



— Do not use your CDs with paste residue or ink attached.



— Do not use CDs with labels or stickers attached, which may leave a sticky residue while beginning to peel off.
(Shown as the picture)



— Clean the discs with an optional cleaning cloth. Wipe each disc from the center out.
(Shown as the picture)

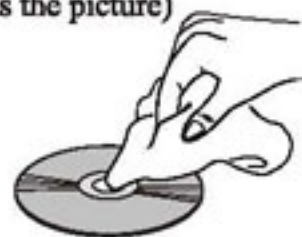

Maintenance

Replacing the Fuse

Make sure the amperage matches the specified value when replacing the fuses. If the fuse is blown, check the power connection and replace with a new one. If the same problem occurs, it would be subjected to the malfunction. In such cases, please consult to the nearest service dealer.

Warning

Never use the fuse with the rated amperage more than that supplied to your unit, otherwise it will damage the unit.

Replacing the Battery

When the range of the operation of the card remote control becomes short or no functions while operating. Replace the lithium battery with a new button cell (CR2025). Make sure the battery polarity before replace.

Gently pull out the Battery Holder while pressing the Stopper.



Put the button-type battery with mark(+) upward into the Battery Holder.

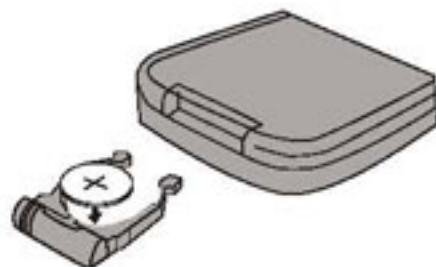

Insert the Battery Holder into the Remote Control.

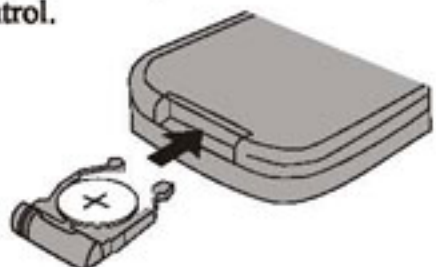

Precautions on Using Lithium Battery

Always keep the lithium battery beyond children's reach. In case swallowed, see a doctor immediately.

Cleaning the battery with a dry cloth, to ensure its perfect connected.

Make sure the proper polarity when loading with the battery.

To prevent short circuit, do not use metal tweezers to clip the battery.

Warning!

Improper handle with the battery may lead to explosion. It cannot be charged, disassembled or thrown into a fire.

Before You Start

Location of the Controls

Front Panel

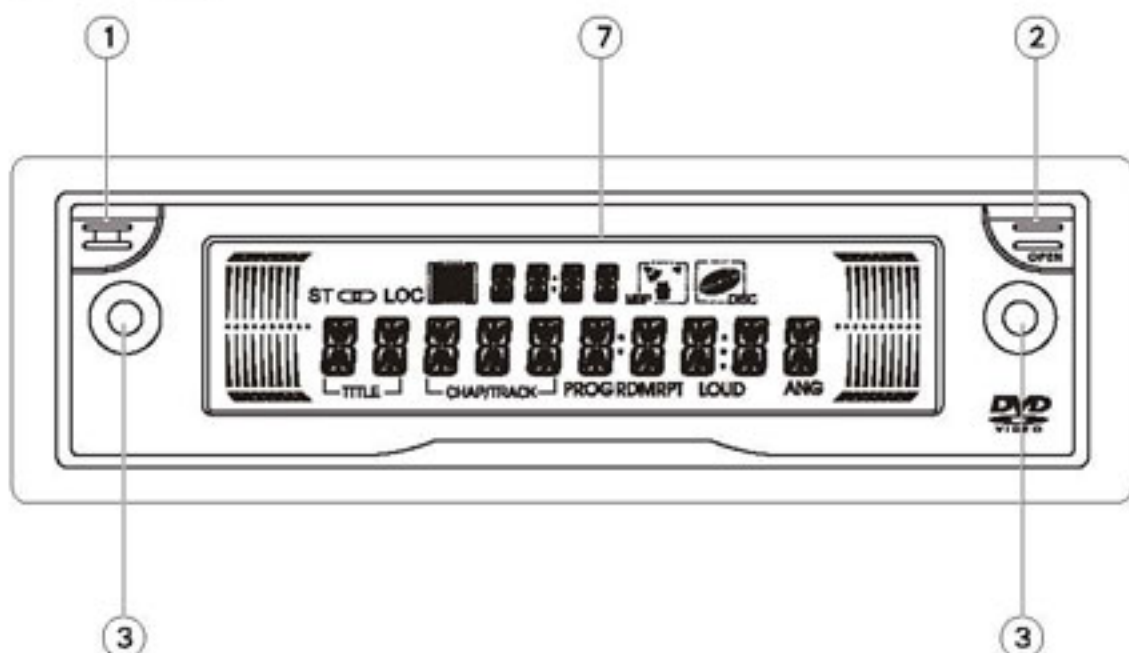

Base

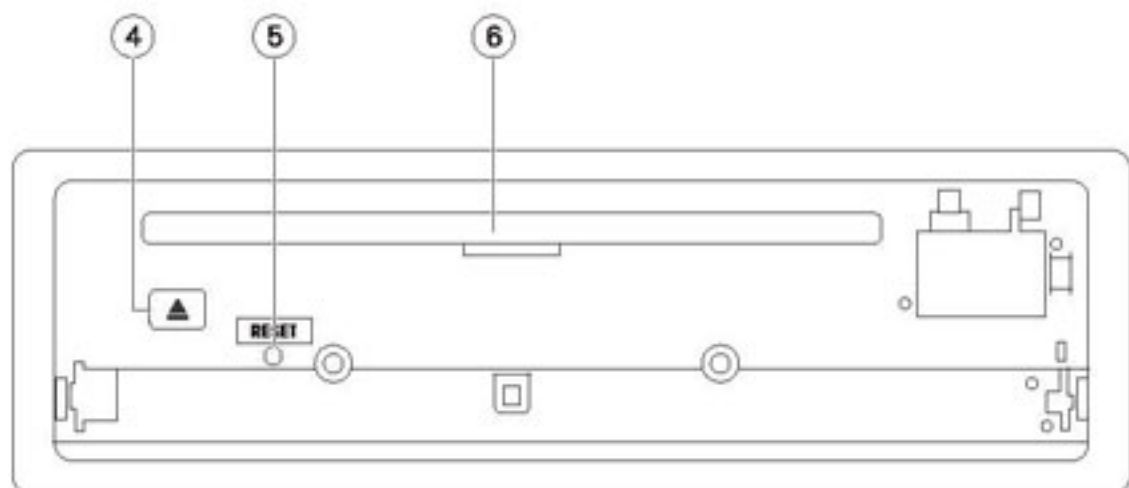

- ① **POWER button**
Press PWR button to turn on the unit,
press it again to turn off the unit.
- ② **OPEN button**
Press this button to release the front
panel.
- ③ **Infrared Sensor**
- ④ **▲ EJECT button**
Press to eject the disc.
- ⑤ **RESET button**
Press to set the unit to initial status.
- ⑥ **Disc Loading Slot**
- ⑦ **LCD (LIQUID CRYSTAL DISPLAY)**
To display the current status.

Before You Start

Card Remote Control

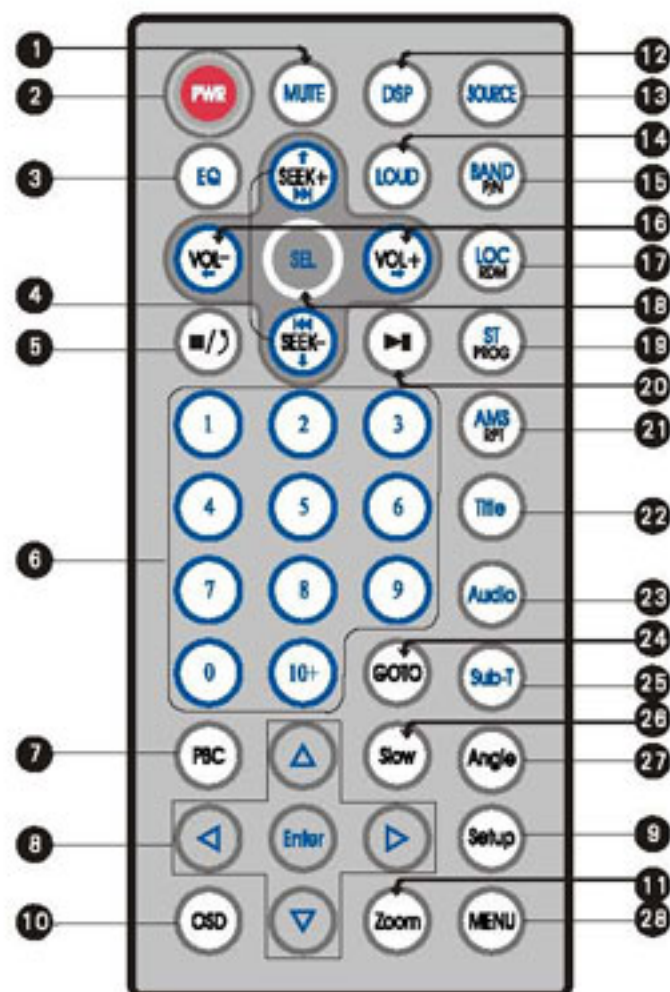

Tips:

For more information as to replacing battery, please refer to **Replacing the Battery** on page 6.

- 1** MUTE
Press to shut off the sound output, press it again to resume previous sound level.
- 2** PWR
Press to turn on or off the unit.
- 3** EQ
Press to select the corresponding preset modes to adjust the sound quality.
- 4** SEEK+/SEEK-
Press to do manual seek tuning and track search controls.
- 5** M/)
Press to stop the playback.
- 6** (0-10+) Number Buttons
Press to select track, chapter, preset stations.

Before You Start

- 7 PBC
Press to display menus.
- 8 [▲][▼][◀][▶][ENTER]
During DVD mode, press to move cursor upward, downward, leftward or rightward, and then press [ENTER] to execute the entering or the selected item in the system setting menu.
- 9 SETUP
During playback mode, press to display system setting picture, the user can select some relative constant parameters.
- 10 OSD
Press to display title, chapter, the elapsed time, remain time.
- 11 ZOOM
Press to increase or decrease the picture in size.
- 12 DSP
Press to display current time.
- 13 SOURCE
Press to select your desired modes.
- 14 LOUD
Briefly press to activate LOUD function.
Press and hold this button for 3 seconds to activate MBP function.
- 15 BAND/ (P/N)
During radio mode, press to select bands.
During DVD, VCD status, press to select PAL or NTSC system.
- 16 VOL+/VOL-
Press to increase or decrease volume level.
- 17 LOC/RDM
During radio status, press to select local station or distance station;
During VCD, CD status, press to play tracks at random order.
- 18 SEL
Repeatedly press to select modes.
- 19 ST/PROG
During radio status, press to select stereo or mono reception;
During playback status, press to set the program order to play.
- 20 ►||
Press to switch sequentially between playback and pause play.
- 21 AMS/RPT
During radio status, press to scan and store station;
During playback status, press to replay.
- 22 TITLE
During DVD mode, repeatedly press to select different titles.
During MP3 mode, press this button to turn the ID3 on or off.
- 23 AUDIO
During DVD mode, press to change the audio language.
During VCD mode, press to change the audio channel.
- 24 GOTO
press to set the playback time.
- 25 SUBTITLE
press to change the subtitle language during DVD playback.
- 26 SLOW
press to slow forward or slow reward.
- 27 ANGLE
Press to change the viewing angle during DVD playback.
- 28 MENU
Press to return to the root menu of the disc during DVD playback.

Before You Start

Specifications

General

Power Requirement	14.4V DC (11-16V allowable)
Load Impedance	4 Ω
Max.Power Output	60W x 4
Tone Controls	\pm 10dB Bass 100Hz Treble 10KHz
Dimensions	Approx. 192 x 178 x 50 mm (d/w/h)
Mounting Dimensions	Approx. 169 x 182 x 53 mm (d/w/h)
Weight	Approx. 1.75kg

FM Section

Tuning Range (Optional)	87.5-108(MHz) (Europe) 87.5-107.9(MHz) (U.S.A.) 65-74(MHz) (Russia)
IF Range	10.7MHz
Usable Sensitivity (-30dB)	10dBuV
Signal-to-noise Ratio	60dB
Stereo Separation	30dB (1KHz)
Frequency Response	30-15000Hz

AM Tuner Section

Frequency Range (Optional)	522-1620(KHz) (Europe/Russia) 530-1710(KHz) (U.S.A.)
IF Range	450KHz
Usable Sensitivity (-20dB)	28dBuV

CD Player Section

VCD Signal System	PAL/NTSC
Signal-to-noise Ratio	65dB
Separation	60dB(1KHz)
Distortion	0.1%

DVD Player Section

Number of channel	2 channels
Frequency Response	5Hz to 20,000Hz
Dynamic Range	98dB
Signal-to-Noise Ratio	73dB
Wow and Flutter	Less than measurable limit

Note:

Due to continuous product improvement, specifications and design are subject to change without prior notice.

Wiring Connection

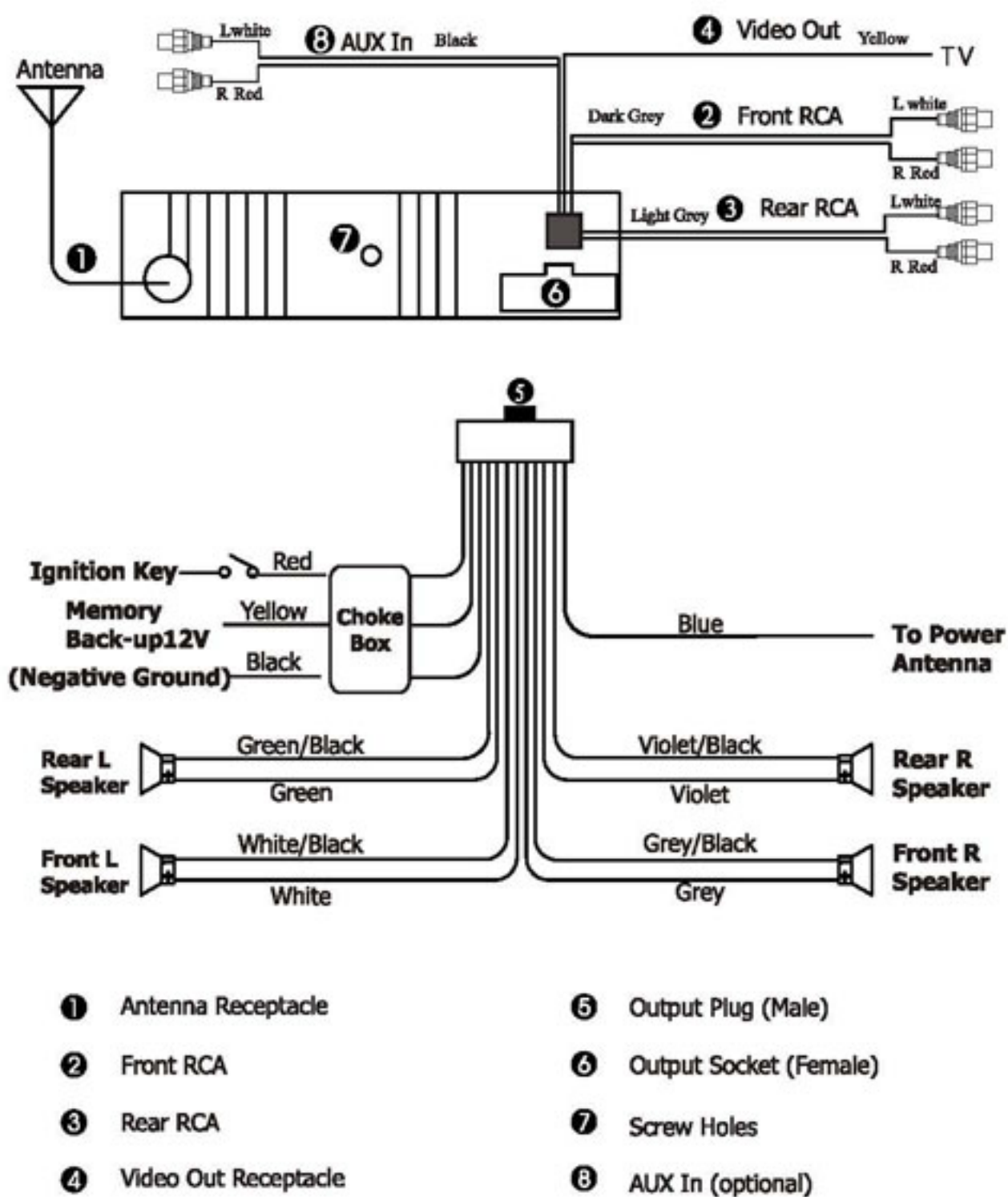

Installation

Install the Front Panel

Put notch (A) (Shown as picture) onto shaft (B) . And then slightly press into the right side.

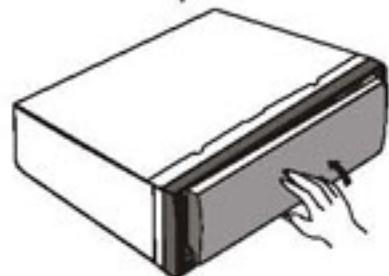
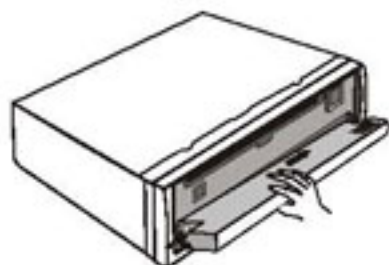
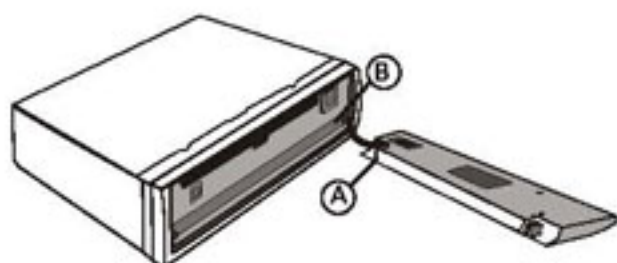

Press (REL) button in the upper right corner, and then the front panel will be folded down.

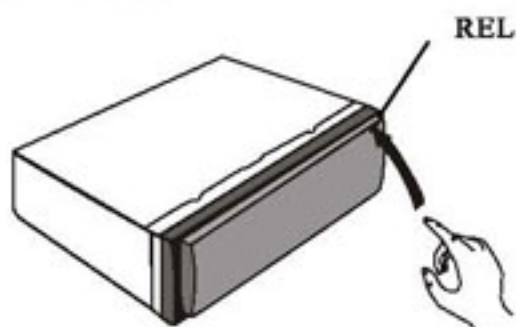

When the front panel was turned down to a position of 45°, hold and slide the front panel to left, and then pull it out .



■ **Note:**

- Never put any objects into the front panel.

Installation Method ① : DIN Front-Mount

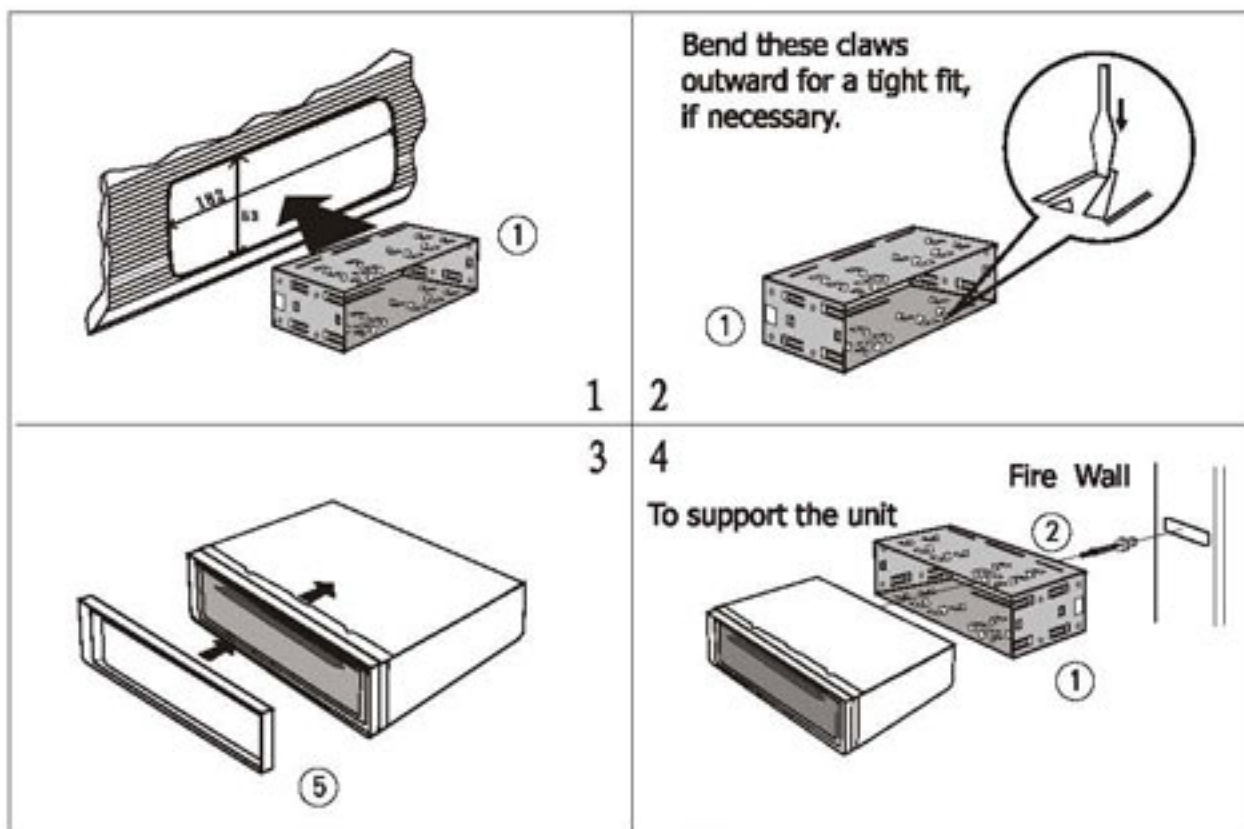

Installation Method ②

Installation using the screw holes at the sides of the unit.

1. Remove the hooks on both sides.
2. Select a position where the screw holes of the mounting bracket supplied with the car and the screw holes of the main unit become aligned (are fitted), and tighten the screws (see ④) at 2 places on each side. And then fasten them to the car.

▣ **NOTE:**

- Outer Trim Frame ⑤ Hook ⑨ and Mounting Sleeve ① are not used for installation method ②

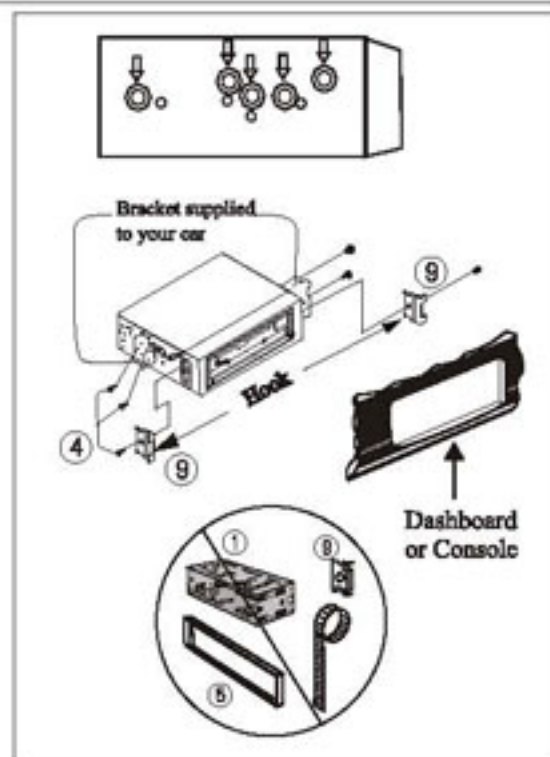

Installation

Detach the Unit

Detach the front panel before disassembling the unit. For more details regarding this section, refer to “Detach the Front Panel” .

1. Take out the Outer Trim Frame after detaching the front panel.

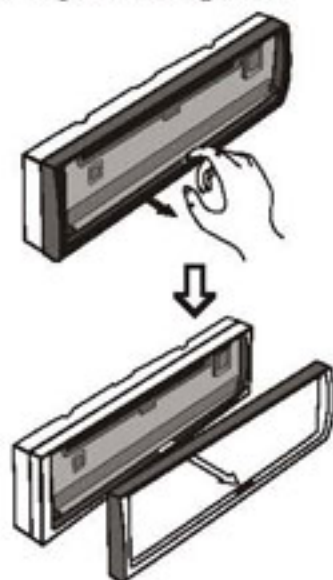

2. Insert the keys supplied to the unit at both sides of the unit (shown as illustrated) until they click. Pulling the keys makes it possible to remove the unit from the dashboard.

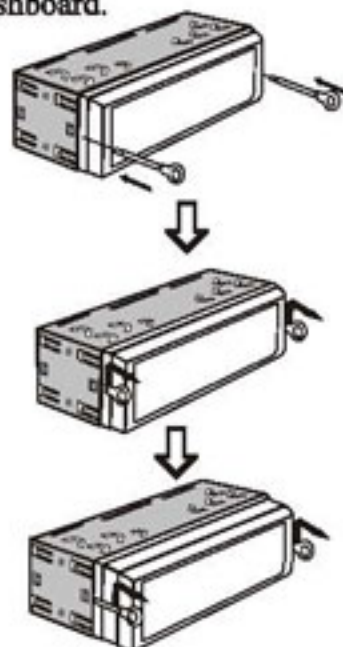

Parts List

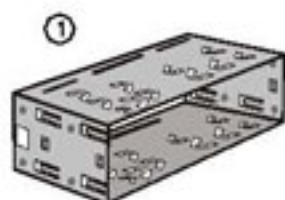

Mounting Sleeve x1



Rear Mounting Bolt x1



Harness Rubber x1



M 5 x 5
4 Screws

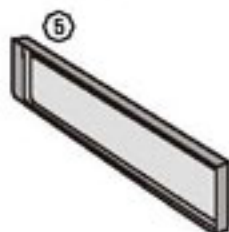

Outer Trim Frame x 1



Keys x 2



Connecting Wire x1



Steel Bar x 1

Cleaning the Connector

If the connector between the main unit and the front panel is dirty, it may result in unit's abnormal working condition. To avoid such problems happening, please detach the front panel, and clean the connector with an alcohol swab. Gently clean and avoid damaging the connector.

The main unit

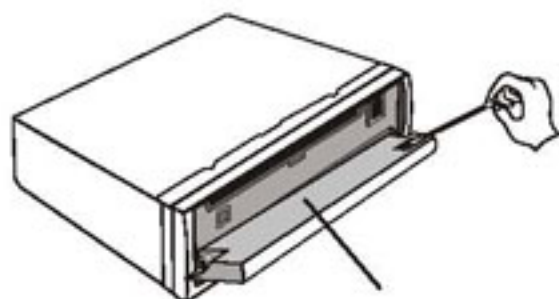
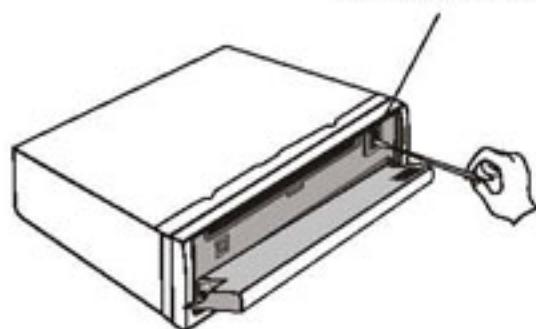

The backside of the front panel

Notes:

- For safekeeping, always shut down the generator and take out the key from the ignition before cleaning.

Never keep your finger or any metal device touch the connector directly.

General Operations

Reset the Unit

Operating the unit for the first time or after replacing the car battery, you must reset the unit.

Remove the front panel at first, and then Press **5** **RESET** button on the base with a pointed object, (such as a ballpoint pen) to set the unit to initial status.

Notes:

- When some errors occur on the display, you can also press **RESET** button to resume to normal, and it will erase the clock setting and some memorized functions.
- This function can only be operated by the head unit.

Turning the Unit On/Off

Press **2** **PWR** button to turn on the unit, press it again, the unit is still in the waiting status. When insert a disc, the unit will automatically start playing. Keep pressing it to turn off the unit completely.

Notes:

- After the unit is off, the volume level is memorized during the area between 6 and 30. If the volume level is set less than 6, it will resume to 6; if it is higher than 30, it will resume to 30; if it is between 6 and 30, it still stores in the status which you set.
- Pressing **PWR** button on the head unit also performs the same operation.

Volume Control

Press **6** **VOL+** button to increase the sound level and press **6** **VOL-** button to decrease the sound level.

Note:

- This function is operated by pressing the remote control only.

Setting the Sound Characteristics

Repeatedly press **8** **SEL** button to select the desired mode in the following order:

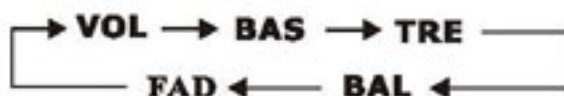

- After selecting the desired mode, you can adjust the current level by pressing **6** **VOL** buttons.
- If you don't adjust **6** **VOL** buttons within 5 seconds after selecting the desired mode, the unit will automatically return to the current mode being displayed.
- when **EQ** mode is activated, press **8** **SEL** button to select modes, **BAS**/**TRE** are invalid. (Shown as below)



Note:

- This function is operated by pressing the remote control only.

EQ Setting

While listening to the popular music, classic music or rock music, you can select the corresponding preset modes to adjust the sound quality perfectly by using **3** **EQ** button.

Repeatedly pressing **3** **EQ** button to choose the following modes in turn:



Notes:

- Bass mode and Treble mode return to initial settings when **EQ** system is on, "Bass" and "Treble" disappear.
- This function is operated by pressing the remote control only.

Turning Loudness On/Off /My Best Position(MBP)

- Briefly press **LOUD** button on the remote control to activate loud function. You can press this button to increase the low frequency, which can improve sensitivity for your ears. And "LOUD" appears. Press it again to shut down "LOUD" function.
- Press and hold this button for more than 3 seconds to activate MBP function. If no passenger in the car, you can perform MBP function and enjoy optimum sound.

LCD	F Speaker		R Speaker	
	L	R	L	R
MBP-A	0	-4dB	-4dB	-8dB
MBP-B	-4dB	0	-8dB	-4dB
MBP-OFF	0	0	0	0

Each time when you press and hold **LOUD** button for 3 seconds, it will select the position as desired in the following order:



The corresponding mode will appear on the display. If accurately adjusting the volume level needed, please use SEL button. (Refer to "Setting the Sound Characteristics" for more details)

Notes:

- When activate BAL and FAD ("Setting the Sound Characteristics"), MBP mode will be turned off.
- This function is operated by pressing the remote control only.

Mute Function

Press **MUTE** button to shut off the sound output. And "MUTE" appears on the LCD. Press it again to resume to previous volume level.

Note:

- This function is operated by pressing the remote control only.

Displaying and Adjusting Time

Displaying Time: Press **DSP** button and the current time is shown on the LCD, it will return to original status after 3 seconds.

Adjusting Time: Press and hold **DSP** button until the two points in the middle of the clock stop blinking, and the "Hour" blinks, you can press **VOL+** or **VOL-** buttons to adjust hours; and then press **SEL** button, and the "Minute" blinks, you can press **VOL+** or **VOL-** buttons to adjust the minutes.

Note:

- This function is operated by pressing the remote control only.

Mode Selector

Press **SOURCE** button to select radio mode or playback mode.

Note:

- This function is operated by pressing the remote control only.

Infrared Sensor:

Receptor **17** on the head unit for the card remote commander.

AUX In (optional)

You can input the audio frequency into the main unit to increase the volume through AUX.

DVD

Basic operation of DVD

Insert a DVD disc into the slot, the unit will automatically switch on, if a DVD disc is loaded, press **(E) SOURCE** on the remote control to start the playback.

Note:

- * Pressing **(4) ▲** button on the head unit to eject a DVD disc.

Selecting Tracks Fast

During DVD playback, firstly press **(4) (⏮)** to play the tracks from the current one, press **(⏮)** within 3 seconds to play the previous track, press **(⏭)** to play the next one.

Note:

- * This function is operated by pressing the remote control only.

Repeat Playing

During DVD playback, repeatedly press **(2) AMS/RPT** to replay the tracks.

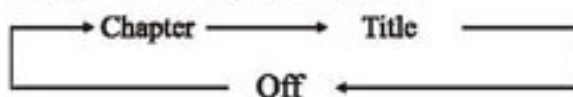

Note:

- * The default setting is **DISC REPEAT**.
- * This function is operated by pressing the remote control only.

Number Buttons

Press one of **(6) Number Buttons(0~9)** to select a track, it will be played automatically.

Note:

- * The function is only valid on remote control.

Stop the playback

During DVD playback, firstly press **(5) (■/⏸)** to pause the playing, press **(20) (⏮)** to replay. Press **(■/⏸)** twice to stop the playback, press **(⏭)** to start playing from the first track of the disc.

Note:

- * This function is only operated by using remote control.

Pause the Playback

During DVD playback, press **(20) (⏮)** to switch between play and stop; During stop mode, press this button to resume playback mode.

Note:

- * This function is only operated by using remote control.

Skip backward/forward/F.F /F.REW the playback

Hold and Press **(4) (⏮ or ⏭)** on remote control to perform fast reward or fast forward. Each pressing will change as follow:

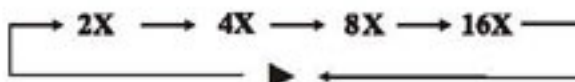

Note:

- * This function is only operated by using remote control.

System Button

During DVD mode, Press **(15) BAND/(P/N)** to select the TV system as follow:

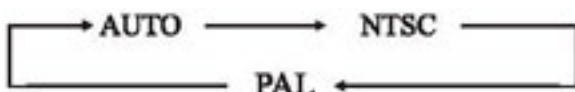

Note:

- * This function is also can be operated by **DVD SETUP MENU**.

Slow motion playback

Press **SLOW** to slow forward or slow backward. There are speeds as follow:

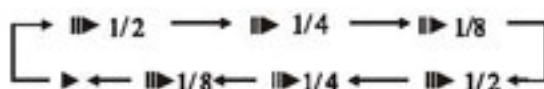

Note:

- This function is only operated by using remote control.

Increase the size of the picture

During DVD mode, Press **ZOOM** to increase the picture in size. There are sizes as follow, Each pressing increases the size until the maximum size is reached.

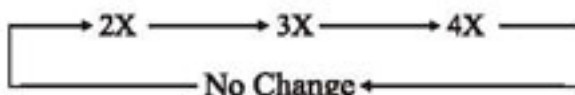

Note:

- The function is only valid on remote control.

On Screen Display

During DVD status, brief press **OSD** button the display shows:

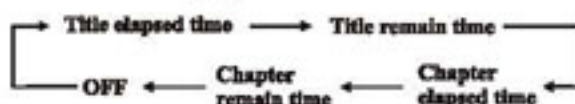

keep pressing **OSD** button to display the current setting.

Note:

- The function is only valid on remote control.

DVD Playback Setting

During DVD mode, press **GOTO** button to set the playing time, when the TFT display : *title/chapter/sound/captions/angle/title time/chapter time/repeat playing/time option*. Press **[▲][▼]** to select the options, press **ENTER** to set the status. Then press **NUMBER BUTTONS** or **[▶][◀]** to set the current status.

Note:

- This function is operated by using the remote control.

Changing the viewing angle (Multi-angle)

With DVDs featuring multi-angle (scenes shot from multiple angles) recordings, you can press **ANGLE** to switch among viewing angles during playback.

Selection options switch as follows:

ANGLE 1 — **ANGLE 2** — **ANGLE 3**

Notes:

- This function is operated by using the remote control.
- This function only operates with DVDs featuring multi-angle recordings.
- The "3" mark on a DVD's package indicates it features multi-angle scenes. The number in the "3" mark indicates the number of angles from which scenes were shot.
- If you press **ANGLE** during fast forward/fast reverse or pause, fast forward/fast reverse or pause is cancelled and normal playback resumes but the viewing angle does not change.

Changing audio language (Multi-audio)

DVDs can provide audio playback with different language. With DVDs featuring multi-audio recordings, you can press **AUDIO** to switch between language and audio systems during playback.

Selection options switch as follows:

AUDIO 1 — **AUDIO 2** — **AUDIO 3**

Notes:

- This function is operated by using the remote control.
- This function only operates with DVDs featuring multi-audio recordings.
- The number in the “**A**” mark on a DVD’s package indicates the number of recorded languages/audio systems.
- During VCD mode, you can press **AUDIO** to select left channel, right channel or stereo channel.

Changing the subtitle language (Multi-subtitle)

With DVDs featuring multi-subtitle recordings. You can press **SUB-T** to switch between subtitle languages during playback.

Selection options switch as follows:

Subtitles 1 — **Subtitles 2** — **Subtitles OFF**

Notes:

- This function is operated by using the remote control.
- This function only operates with DVDs featuring multi-subtitle recordings.
- The number in the “**S**” mark on a DVD’s package indicates the number of recorded subtitle languages.

Selecting MENU

- 1 **Selecting Menu:** During DVD status, press **MENU** to return to the root menu, all of the chapters will appear on monitor. You can press **8** or **6** button to select your desired chapter.
- 2 **Selecting Title:** During DVD status, press **TITLE** to return the title menu, all of the titles will appear on monitor. You also can press **8** or **6** button to select your desired chapter.

Note:

- The function is only valid on remote control.

SET UP MENU

During DVD playback, press **SET UP**, the screen will display system setting picture, the user can select some relative constant parameters. The user also can set it as needed by moving the cursor and using **8** [**▲**][**▼**][**◀**][**▶**] buttons, and then press **ENTER** to execute the selecting or entering item.

Notes:

- This function is operated by using the remote control.
- The selections are the preferred options that will be chosen if they are available on a disc. If the disc that is inserted does not have the preferred option then the disc’s own preference will be used.
- Regarding **SETUP MENU**, please refer to the following pages for more details.
- Some functions varies depending on the types of models or formats of the disc.

--General Setup Page--**TV Display**

Example showing how to set TV Display mode:

(Press ▲ or ▼)

--General Setup Page--

TV Display	Wide
Angle Mark	On
OSD Lang	Eng
Captions	Off
Screen Saver	On

Go To General Setup Page



(Press ► , ▲ or ▼ , then press ENTER)

--General Setup Page--

TV Display	Wide	Normal/PS
Angle Mark	On	Normal/LB
OSD Lang	Eng	Wide
Captions	Off	
Screen Saver	On	

Set TV Display mode

Angle Mark

Example showing how to set picture mode:

(Press ▲ or ▼)

--General Setup Page--

TV Display	Wide
Angle Mark	On
OSD Lang	Eng
Captions	Off
Screen Saver	On

Go To General Setup Page



(Press ► , ▲ or ▼ , then press ENTER)

--General Setup Page--

TV Display	Wide	
Angle Mark	On	On
OSD Lang	Eng	Off
Captions	Off	
Screen Saver	On	

Set Angle Mark

OSD Lang

Example showing how to set language mode:

(Press ▲ or ▼)

--General Setup Page--

TV Display	Wide
Angle Mark	On
OSD Lang	Eng
Captions	Off
Screen Saver	On

Go To General Setup Page



(Press ► , ▲ or ▼ , then press ENTER)

--General Setup Page--

TV Display	Wide	
Angle Mark	On	
OSD Lang	Eng	English
Captions	Off	
Screen Saver	On	

Set OSD Language

--General Setup Page--**Captions**

Example showing how to set captions on/off:

(Press ▲ or ▼)

--General Setup Page--	
TV Display	Wide
Angle Mark	On
OSD Lang	Eng
Captions	Off
Screen Saver	On

Go To General Setup Page



(Press ►, ▲ or ▼, then press ENTER)

--General Setup Page--		
TV Display	Wide	
Angle Mark	On	
OSD Lang	Eng	
Captions	Off	On
Screen Saver	On	Off

Closed Captions

Screen Saver

Example showing how to set Screen Saver on/off:

(Press ▲ or ▼)

--General Setup Page--	
TV Display	Wide
Angle Mark	On
OSD Lang	Eng
Captions	Off
Screen Saver	On

Go To General Setup Page



(Press ►, ▲ or ▼, then press ENTER)

--General Setup Page--		
TV Display	Wide	
Angle Mark	On	
OSD Lang	Eng	
Captions	Off	
Screen Saver	On	On
		Off

Screen Saver

--Dolby Digital Setup--

Dual Mono Example showing how to set stereo mode:

(Press ▲ or ▼)

--Dolby Digital Setup--

Dual Mono
Dynamic

Go To Dolby Digital Setup

⇒

(Press ▶, ▲ or ▼, then press ENTER)

--Dolby Digital Setup--

Dual Mono	Stereo
Dynamic	L-Mono
	R-Mono
	Mix-Mono

Dual Mono (1+1) Setup

Dynamic Example showing how to set dynamic range compression:

(Press ▲ or ▼)

--Dolby Digital Setup--

Dual Mono
Dynamic

Go To Dolby Digital Setup

⇒

(Press ▶, ▲ or ▼, then press ENTER)

--Dolby Digital Setup--

Dual Mono	
Dynamic	-- FULL
	-- 3/4
	-- 1/2
	-- 1/4
	-- OFF

Set DRC off

---Preference page---

TVType

Example showing how to set TV type:

(Press ▲ or ▼)

--Preference Page--	
TVType	Auto
Audio	Eng
Subtitle	Eng
Disc Menu	Eng
Parental	
Password	
Default	

Go To Preference Page



(Press ►, ▲ or ▼, then press ENTER)

--Preference Page--		
TVType	Auto	PAL
Audio	Eng	Auto
Subtitle	Eng	NTSC
Disc Menu	Eng	
Parental		
Password		
Default		

Set TV Standard

Audio

Example showing how to set Audio language:

(Press ▲ or ▼)

--Preference Page--	
TVType	Auto
Audio	Eng
Subtitle	Eng
Disc Menu	Eng
Parental	
Password	
Default	

Go To Preference Page



(Press ►, ▲ or ▼, then press ENTER)

--Preference Page--		
TVType	Auto	
Audio	Eng	English
Subtitle	Eng	
Disc Menu	Eng	
Parental		
Password		
Default		

Preferred Audio Language

Subtitle

Example showing how to set subtitle language:

(Press ▲ or ▼)

--Preference Page--	
TVType	Auto
Audio	Eng
Subtitle	Eng
Disc Menu	Eng
Parental	
Password	
Default	

Go To Preference Page



(Press ►, ▲ or ▼, then press ENTER)

--Preference Page--		
TVType	Auto	
Audio	Eng	
Subtitle	Eng	English
Disc Menu	Eng	Off
Parental		
Password		
Default		

Preferred subtitle Language

---Preferences page--

Disc Menu Example showing how to set Disc Menu Language:

(Press ▲ or ▼)

--Preference Page--

TV Type	Auto
Audio	Eng
Subtitle	Eng
Disc Menu	Eng
Parental	
Password	
Default	

Go To Preference Page

➔

(Press ▶, ▲ or ▼, then press ENTER)

--Preference Page--

TV Type	Auto	
Audio	Eng	
Subtitle	Eng	
Disc Menu	Eng	English
Parental		
Password		
Default		

Preferred Menu Language

Parental Example showing how to set parental control:

(Press ▲ or ▼)

--Preference Page--

TV Type	Auto
Audio	Eng
Subtitle	Eng
Disc Menu	Eng
Parental	
Password	
Default	

Go To Preference Page

➔

(Press ▶, ▲ or ▼, then press ENTER)

--Preference Page--

TV Type	Auto	2 G ▲
Audio	Eng	3 PG
Subtitle	Eng	4 PG 13
Disc Menu	Eng	5 PGR
Parental		6 R
Password		7 NC 17
Default		8 Adult
		Off

Set Parental Control

Password Example showing how to set password, and the default password is 8888.

(Press ▲ or ▼)

--Preference Page--

TV Type	Auto
Audio	Eng
Subtitle	Eng
Disc Menu	Eng
Parental	
Password	
Default	

Go To Preference Page

➔

(Press ▶, ▲ or ▼, then press ENTER)

--Preference Page--

TV Type	Auto	
Audio	Eng	
Subtitle	Eng	
Disc Menu	Eng	
Parental		
Password		Change
Default		

Change Password

---Preferences page--

Default

Example showing how to set load factory setting:

(Press ▲ or ▼)

--Preference Page--	
TVType	Auto
Audio	Eng
Subtitle	Eng
Disc Menu	Eng
Parental	
Password	
Default	

Go To Preference Page



(Press ►, ▲ or ▼, then press ENTER)

--Preference Page--	
TVType	Auto
Audio	Eng
Subtitle	Eng
Disc Menu	Eng
Parental	
Password	
Default	Reset

Load Factory Setting

Playing a Mp3 Disc

Insert a MP3 disc into the slot, the unit will automatically switch on, if a MP3 disc is loaded, press SOURCE to start the playback. During MP3 playback, the moving playing information displays on LCD. When playing a disc included PIC file, first press **5** **■/)**, then press **[▲][▼]** to select the option.

▣ Note:

- * You can eject a MP3 disc by pressing **▲** on the base or **▲** on the remote control.

Selecting Tracks Fast

During Mp3 playback, press **4** **⏮** to play the backward track, Press **4** **⏭** to play next track.

▣ Note:

- * This function is operated by using the remote control.

Repeat Playing

During Mp3 playback, press **21** **RPT** to replay the current track, press it again to cancel this function.

▣ Note:

- * This function is operated by using the remote control.
- * The default setting is Disc Repeat.

Number Buttons

Press one of **6** **Number Buttons(0~9)** to select a track to play automatically.

▣ Note:

- * This function is operated by using the remote control.

Stop Playing

During Mp3 playback, Press **5** **■/)** to stop the playback.

▣ Note:

- * This function is operated by using the remote control.

Selecting the MP3 Track

During Mp3 mode, firstly press **24** **GOTO** and the TFT shows:---. Then press **6** **NUMBER BUTTONS** to input the Mp3 track's Number to play it,; secondly press **GOTO** button, and the TFT shows : --:-- , now input the desired Number to play the current track at this point.

▣ Note:

- * This function is operated by using the remote control.

Pause the Playback

During Mp3 playback, press **20** **⏸** to switch between play and stop.

▣ Note:

- * This function is operated by using the remote control.

Skip backward/forward/F.F /F.REW the playback

Hold and Press **4** (**⏮** or **⏭**) on remote control to perform fast reward or fast forward. Each pressing will change as follow:

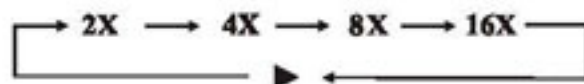

▣ Note:

- * This function is operated by using the remote control.

On Screen Display

keep pressing and hold **10** **OSD** button to display the current status.

VCD/CD

Basic operation of VCD/CD

Insert a VCD/CD disc into the slot, the unit will automatically switch on, if a VCD disc is loaded, press **Ⓛ** **SOURCE** on the remote control to start the playback.

▣ Note:

- * Pressing **⏏** button on the head unit to eject a VCD/CD disc.

Selecting Tracks Fast

During VCD/CD playback, firstly press **⏪** (**⏪**) to play the tracks from the current one, press **⏪** within 3 seconds to play the previous track, press **⏩** to play the next one.

▣ Note:

- * This function is operated by using the remote control.

Repeat Playing

During VCD/CD playback, repeatedly press **Ⓛ** **AMS/RPT** to replay the single track. Press it again to cancel this function.

▣ Notes:

- * The default setting is **DISC REPEAT**.
- * This function is operated by using the remote control.

Playing Tracks in Random Order

During VCD/CD status, when pressing **Ⓛ** **LOG/RDM** button, the unit plays any track at random. Press it again to return to normal playing.

▣ Note:

- * This function is operated by using the remote control.

Number Buttons

Press one of **Ⓛ** **Number Buttons(0~9)** to select a track, it will be played automatically.

▣ Note:

- * The function is only valid on remote control.

Stop the playback

During VCD/CD playback, firstly press **Ⓛ** **⏸** to pause the playing, press **Ⓛ** **⏮** to replay. Press **⏸** twice to stop the playback, press **⏩** to start playing from the first track of the disc.

▣ Note:

- * This function is only operated by using remote control.

Pause the Playback

During VCD/CD playback, press **Ⓛ** **⏸** to switch between play and stop; During stop mode, press this button to resume playback mode.

▣ Note:

- * This function is operated by using the remote control.

Skip backward/forward/F.F /F.REW the playback

Hold and Press **Ⓛ** (**⏮** or **⏩**) on remote control to perform fast reward or fast forward. Each pressing will change as follow:

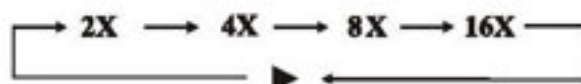

▣ Note:

- * This function is operated by using the remote control.

System Button

During VCD/CD mode, Press **15 BAND/ (P/N)** to select the TV system as follow:

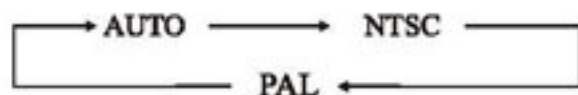

Note:

- * This function is also can be operated by *DVD SETUP MENU*.

Increase the size of the picture

During VCD/CD mode, Press **11 ZOOM** to increase the picture in size. There are sizes as follow, Each pressing increases the size until the maximum size is reached.

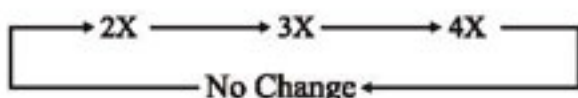

Note:

- * The function is only valid on remote control.

Slow motion playback

During VCD playback, press **26 SLOW** to slow forward. There are speeds as follow:

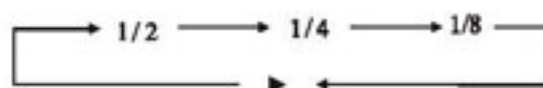

Note:

- * This function is only operated by using remote control.

On Screen Display

During VCD/CD status, brief press **10 OSD** button the display shows:

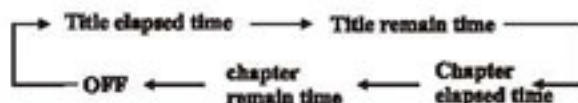

keep pressing **10 OSD** button to display the current setting.

Note:

- * The function is only valid on remote control.

Setting the Playback Time

During CD playback, firstly press **24 GOTO**, and TFT shows : *disc playback time:--:--*, press your desired time of the playback by using number buttons.

Secondly press **GOTO** button, *the tracks time* appears on TFT, also input your desired numbers to play the current time of your selection.

During VCD mode, press **24 GOTO** button to set the playing time, when the TFT display : *title/chapter/sound/captions/angle/title time/chapter time/repeat playing/time option*. Press **3 [▲][▼]** to select the options, press ENTER to set the status. Then press **6 NUMBER BUTTONS** or **3 [▶][◀]** to set the current status.

Note:

- * This function is operated by using the remote control.

VCD/CD

Selecting Channel

During VCD/CD status, repeatedly press **23** AUDIO button to select the following channel:



Selecting the corresponding channel to set the different sound characters.

Note:

- * The function is only valid on remote control.

Title Selector

During VCD status, Press **7** TITLE button to return the root menu of the disc, the TFT displays all the tracks of the disc. You can also press **6** button to choose the desired tracks.

Note:

- * The function is only valid on remote control.

Program Playing

During VCD/CD mode, press **19** PROG, the TFT displays the program menu. Pressing **NUMBER BUTTONS** to select the track Number and then press **8** to move the cursor to *START*, press **ENTER** to start program playing; move the cursor to *EXIT* and press **ENTER** to exit the program playing. Move the cursor to **⏮** and press **ENTER** to the last page; move the cursor to **⏭** and press **8** **ENTER** to the next page.

During this process, press **5** **⏸** to cancel the program playing.

Note:

- * The function is only valid on remote control.

Band Selector

During radio status, repeatedly press **Ⓛ** BAND/(P/N) button to select bands in the following order:

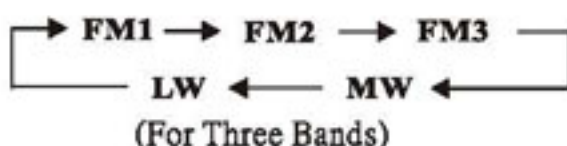
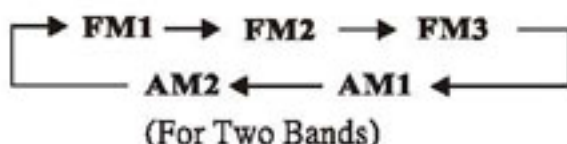

■ Note:

- This function is operated by using the remote control.
- Hold and press BAND button to change the FM between USA and Europe.

Manual/Automatic Tuning

Manual Tuning: Press **⏪** (◀) or **⏩** (▶) button on the remote control continuously to select a station downward or upward respectively.

Automatic Tuning: Press and hold **⏪** (◀) or **⏩** (▶) button for more than 3 seconds, the radio automatically searches a station downward or upward respectively and plays when it finds a station.

■ Note:

- This function is operated by using the remote control.

DX/LOC Selector

During radio status, press **Ⓛ** LOC/RDM button on the remote control to select strong or weak station reception.

- 1 It is set to LOC mode when **Ⓛ** LOC/RDM button is first pressed. "LOC" appears on the display and only local station is available.
- 2 It is switched to DX mode when **Ⓛ** LOC/RDM is pressed again. Both distance and local stations can be received.

■ Notes:

- The initial mode is DX mode.
- LOC mode is functional only in selecting & memorizing stations.
- This function is only operated by using remote control.

MO/ST Selector

During radio status, you can press **Ⓛ** ST/PROG button on the remote control to select **Mono** mode or **Stereo** mode.

- 1 Stereo reception is charged when "ST" and "Ⓛ" appear.
- 2 It is switched to **MONO** mode when "ST" and "Ⓛ" disappear.

■ Note:

- This function is only operated by using remote control.

Tuner

Scanning/Memorizing Stations Automatically

During radio mode, you can press **AMS/RPT** button to scan each stored station 5 seconds respectively which stored in **(1-6) Number Buttons**. You can press the corresponding number buttons or AMS button when your desired station is charged. And it starts playing that station.

When press and hold **AMS/RPT** button for more than 3 seconds, it will activate automatically memory storing function. The radio automatically selects a station and has it stored in any one of the Number Buttons from 1 to 6.

Notes:

- The unit can be stored up to 6 stations for each band.
- Regarding the function of Number Buttons, refer to **Number Buttons** for more information.
- This function is only operated by using remote control.

Number Buttons

During radio mode, **Number Buttons from 1 to 6** can help you store your favorite station. You can follow the steps as below:

When receiving a station, press and hold any one of the Number Buttons until “**CH**” appears in the LCD, which indicates that station is already stored in the corresponding number button.

You can store up to 18 FM stations (6 each for FM1,FM2,FM3), up to 12AM stations (6 each for AM1/MW and AM2/LW).

Note:

- This function is only operated by using remote control.

Simple Troubleshooting Guide

The following checklist might help to solve the problems which you meet when using the unit. Please double check and make sure if the connection and the procedure of the operation is properly before using the checklist below .

Problem	Cause/Solution
No power.	<ul style="list-style-type: none"> • Check and make sure whether the fuse is blown, replace with the proper value if necessary.
Some errors occur in the LCD or no function when pressing the button.	<ul style="list-style-type: none"> • Press RESET button.
Unable to receive stations.	<ul style="list-style-type: none"> • Check and make sure whether the antenna is inserted or the antenna is properly connected, if not, insert the antenna or connect it properly.
Poor effect on receiving a station.	<ul style="list-style-type: none"> • Antenna may not be the proper length. Make sure the antenna is fully extended; if broken, replace the antenna with a new one. • The antenna is poorly grounded, check and make sure the antenna is properly grounded at its mounting location. .
CDs cannot be loaded.	<ul style="list-style-type: none"> • A CD is loaded in the mechanism.
Sound skips.	<ul style="list-style-type: none"> • The CD is dirty or damaged.
No images.	<ul style="list-style-type: none"> • The Video line from main unit to the TV is not connected properly.
Images skip.	<ul style="list-style-type: none"> • Improper setting of the color system. Set the color system to "PAL" or "NTSC" according to the connected television.

Note:

If any of the problem persist after check list had been made, consult your nearest service dealer. Never attempt to disassemble your unit by yourself.



Due to continuous product improvement, the operations are subject to run the model.